



5F, No.371-1, Sec.2, Chung shan Road, Chung Ho, Taipei county Taiwan

TEL : 886-2-82277070

FAX : 886-2-82277171

E-mail : lightop@anet.net.tw

光 楠 科 技 股 份 有 限 公 司  
LIGHTOP TECHNOLOGY CO., LTD.

**Data Sheet**

---

REVISION	02
ISSUE DATE	2007/11/10
APPROVAL BY	JASON
PREPARED BY	LUOFAXING

**Features:**

- 1. Low power consumption
- 2. High efficiency
- 3. Reliable and rugged
- 4. Chip Material: AlGaInP
- 5. Lens Color: Water clear
- 6. Source Color: RED

**Outline Dimensions:**

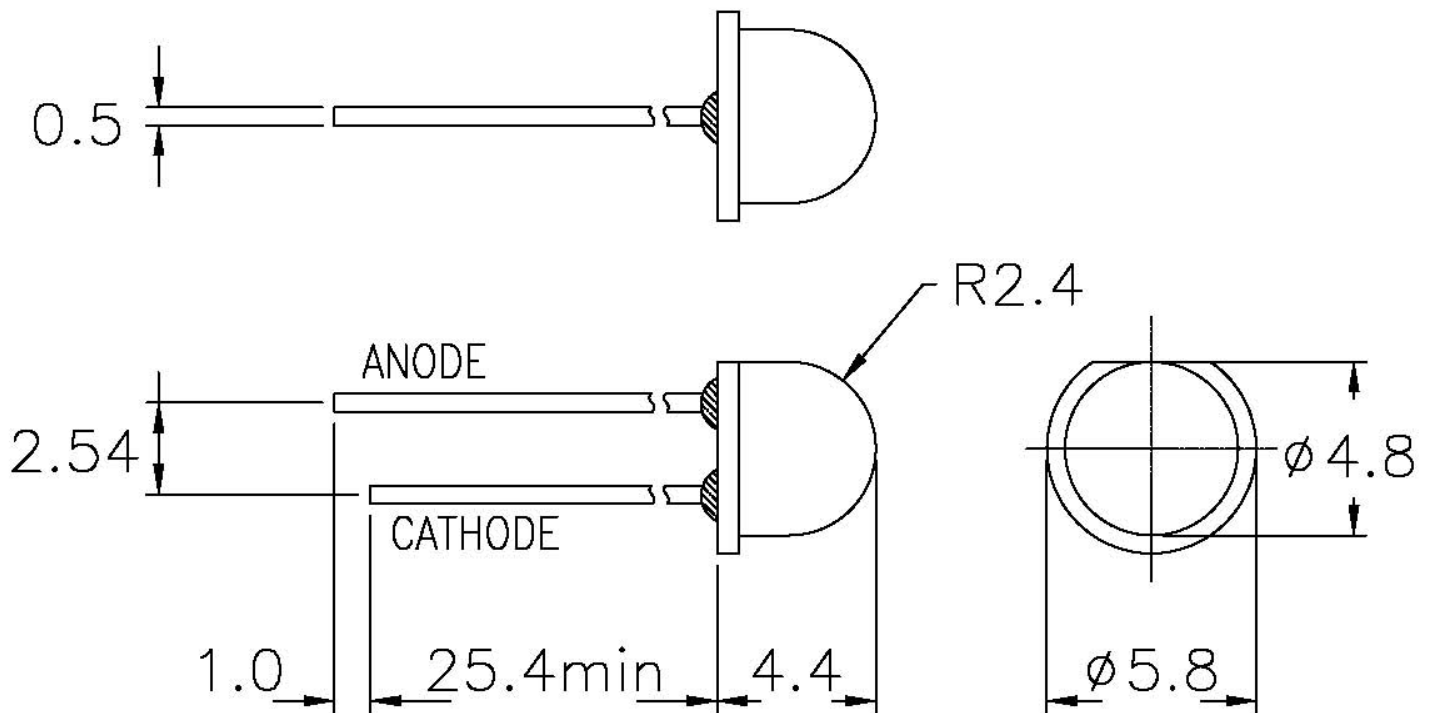

Note :

- 1. All dimensions are in millimeters (inches)
- 2. Tolerance is  $\pm 0.25$ mm (0.010") unless otherwise noted
- 3. Specifications are subject to change without notices.

**Absolute Maximum Ratings at Ta=25°C :**

Parameter	Maximum	Unit
Power Dissipation	75	mW
Peak Forward Current (1/10 Duty Cycle,0.1ms Pulse Width)	100	mA
Continuous Forward Current	25	mA
Derating Linear From 50°C	0.4	mA/°C
Reverse Voltage	5	V
Operating Temperature Range	-20°C to +80°C	
Storage Temperature Range	-30°C to +85°C	
Lead Soldering Temperature [1.6mm(0.63") from body]	260°C for 3 Seconds	

**Electrical/Optical Characteristics at Ta=25°C :**

Parameter	Symbol	Test Condition	Min.	Typ.	Max.	Unit
Luminous Intensity	I <sub>v</sub>	I <sub>F</sub> =20mA	220	500	1000	mcd
Dominant Wavelength	λ <sub>d</sub>	I <sub>F</sub> =20mA	615	620	625	nm
Viewing Angle	2 θ 1/2	I <sub>F</sub> =20mA		85		deg
Forward Voltage	V <sub>F</sub>	I <sub>F</sub> =20mA	1.6	2.0	2.6	V
Reverse Current	I <sub>R</sub>	V <sub>R</sub> =5V			10	uA

**Typical Electrical/Optical Characteristics Curve:**

(25°C Ambient Temperature Unless Otherwise Noted)

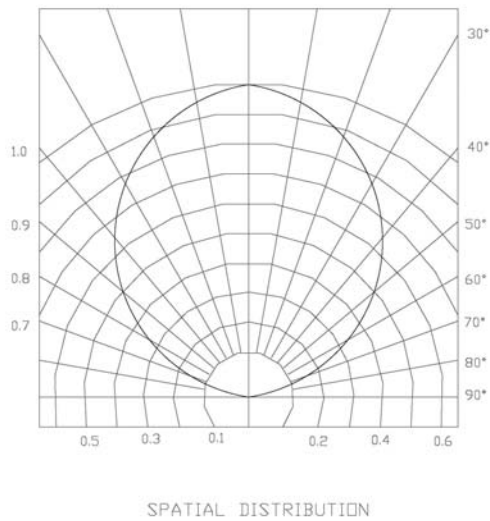
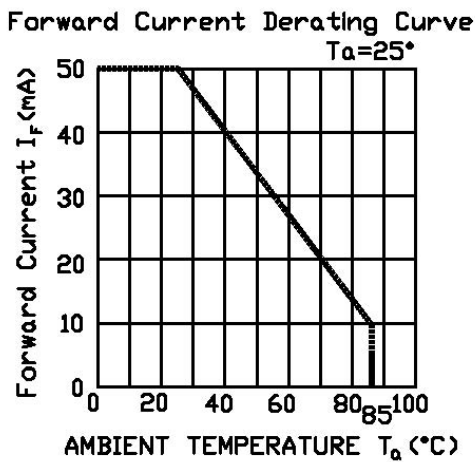
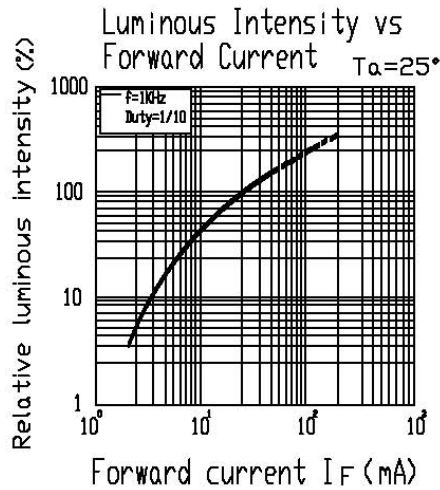
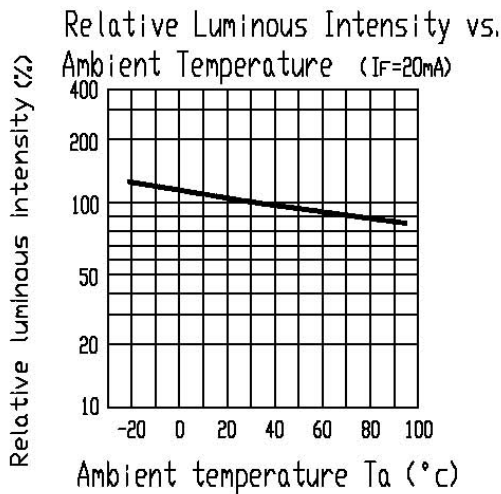
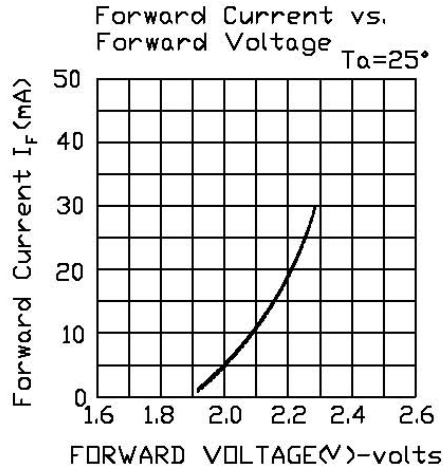
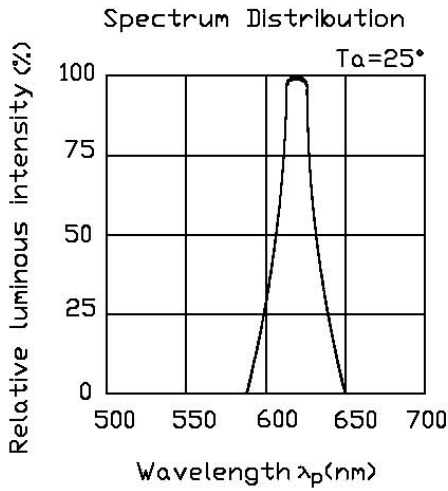

## ● Test Circuit

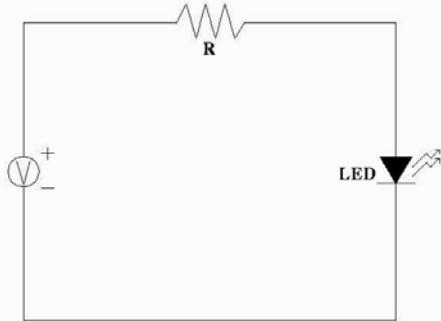

## Reliability Test Standard

NO	Test Item	Test state	Test Conditions	Test Hours/Cycle	Sample /Size	Ac/Re
1	Solder Heat	Motionless state	TEMP:260°C±5°C	10SEC	40PCS	0/1
2	DC Operating Life	Development	TEMP:23±5°C IF=20mA	1000HRS	40PCS	0/1
3	High Temperature Storage	Motionless state	TEMP:105°C	1000HRS	40PCS	0/1
4	Low Temperature Storage	Motionless state	TEMP:-45°C	1000HRS	40PCS	0/1
5	High Temperature High Humidity	Development	Ta= 65±5°C RH= 90 ~ 95%	240H±2H	40PCS	0/1
6	Temperature Cycle	Development	H:+65°C 95% 1H┆10MIN L:-25°C 1H	40CYCLES	40PCS	0/1
7	Thermal Shock	Motionless state	H:+105°C 30min ┆3MIN L:-45°C 30min	20CYCLES	40PCS	0/1